

Brand

TOTO

Product Name

CS989VY / TCF9788WSP

Description

- NEOREST AH 'S trap' Luxurious integrated toilet
- EWATER+ automatically spreads out and keeps clean toilet bowl and nozzle by preventing bacteria with sanitizing effect
- New RIMLESS DESIGN. Simply beautiful in shape with no shaded area make cleaning easier
- TORNADO FLUSH system. 360° cleaning power reaches every spot using less water
- CeFiONtect prevents debris on toilet surface
- PREMIST water is sprayed to make it difficult for dirt to adhere
- SELF-CLEANSING WAND where wand self-cleans before and after every use
- AIR-IN WONDERWAVE Cleansing provides eco-friendliness
- Come with ABB F202 RCCB
- Refer to 2nd page for detail functions

Colour / Material

White

Specifications

Flush System	: Tornado Flush
Water Usage	: 3.9 / 2.8L
Rough-in	: 305 mm
Size	: 386W x 691D x 528H mm
Water Pressure	: 0.05Mpa ~ 0.75Mpa
Power Rating	: 220 ~ 240V 50/60Hz
Power Cord	: 5 m
Length	



NEOREST FUNCTIONS

Hygiene Functions		Cleansing Functions		Comfort Functions	
Actilight		Air-In Wonder-Wave	•	Auto Open / Close Lid	•
Ewater +	•	Rear Cleansing	•	Auto Flush	•
Tornado Flushing	•	Rear Soft Cleansing	•	Instant Heated Seat	
CeFiontect	•	Front Cleansing	•	Heated Seat	•
Rimless	•	Wide Front Cleansing	•	Dryer	•
Premist	•	Oscillating Cleansing	•	Deodorizer	•
Self-Cleaning Wand	•	Pulsating Cleansing	•	Soft Light	•
Antibacterial Feature	•	Water Pressure Control	•	Energy Save Timer	•
		Wand Position Adjustment	•	Auto Energy Saver	•

Electrical Installation Requirements for TOTO Washlet & Neorest

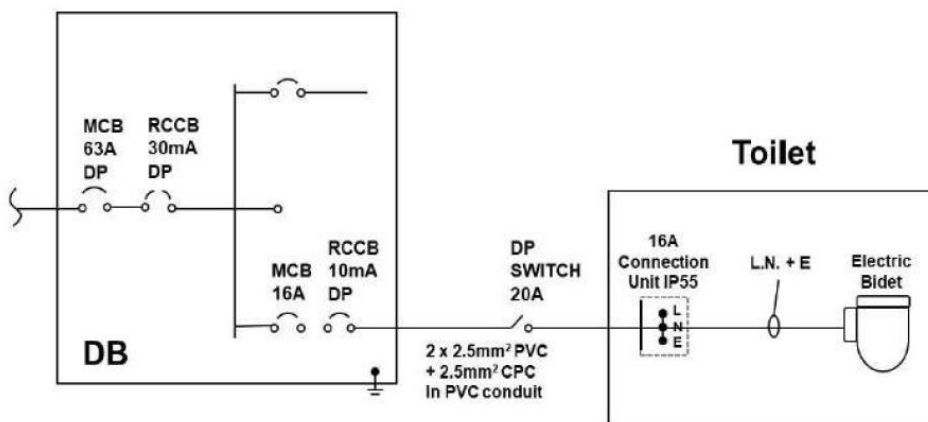
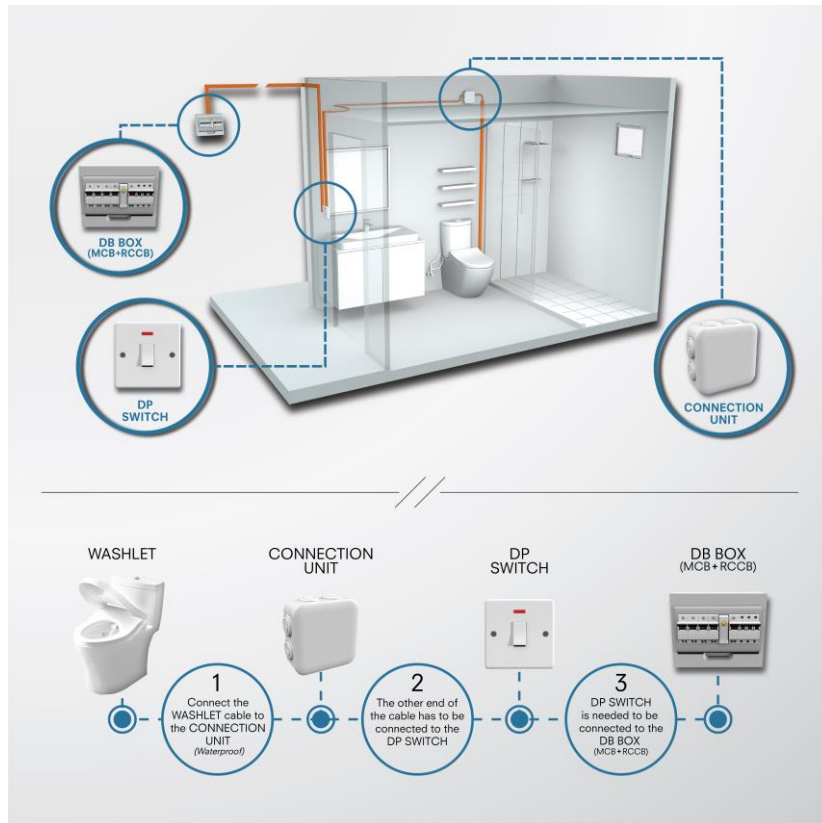

Remarks:

The above information is a guideline and subjected to local code of practice and requirement. Please engage competent Electrical Contractor and Licensed Electrical Worker to carry out the work prior for inspection and certification.