

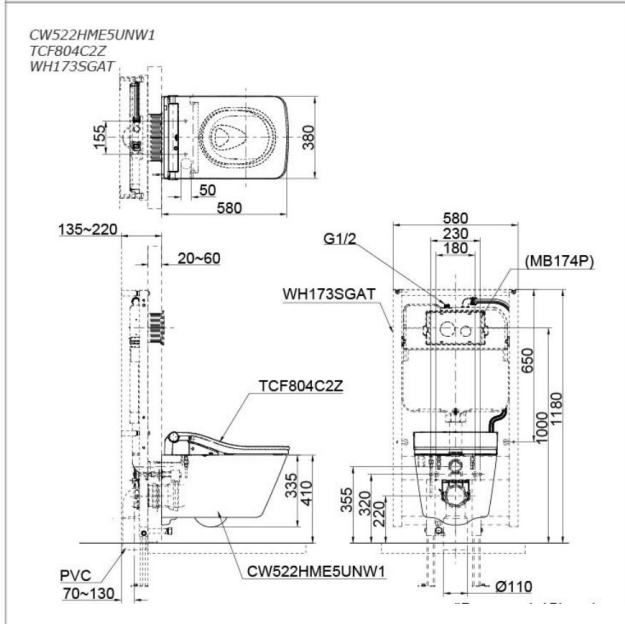

✔✔ Very Good



Brand

TOTO

Product Name

CW522HME5UNW1

Description

- CEFIONTECT Technology: super smooth, ion barrier glazing for a clean toilet bowl
- TORNADO FLUSH for powerful flushing with less amount of water
- RIMLESS DESIGN bowl ensures easy cleaning and ultimate hygiene
- EWATER+ keeps nozzle and bowl clean with sanitizing effect against bacteria
- Fully equipped with rear, front and oscillating & pulsating cleansing function
- Temperature control HEATED SEAT
- PREMIST a fine spray of mist making it difficult for dirt to adhere
- Auto lid opening and closing

Colour / Material

White

Specifications

Flush System	: Tornado, Dual Flush
Water Usage	: 4.0 L / 3.0 L
Rough-in	: 220 mm (P-Trap)
Size	: 380W x 580D x 335H mm
Water Pressure	: 0.05MPa ~ 0.75MPa

TOTO

K9203R FIXING KIT INSTALLATION MANUAL

Included Parts

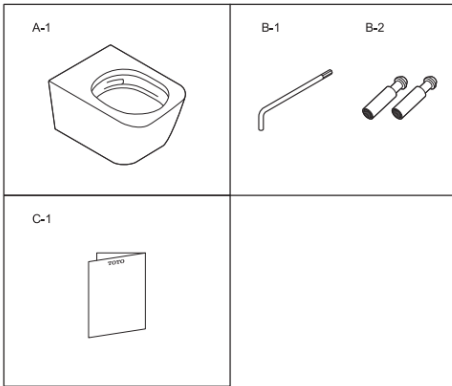

Parts name

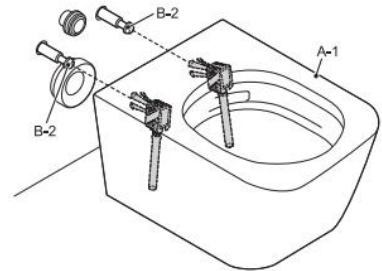

* The product may be slightly different in shape than the product shown in the figure depending on the model.

Installation Procedure

1

For finished wall surfaces

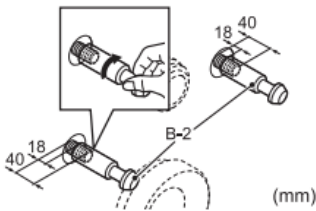

When using a sound insulation mat

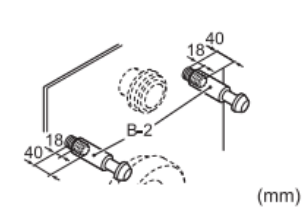

2

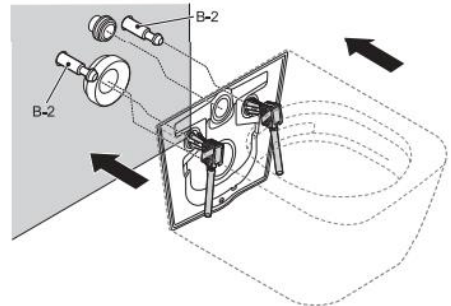

3

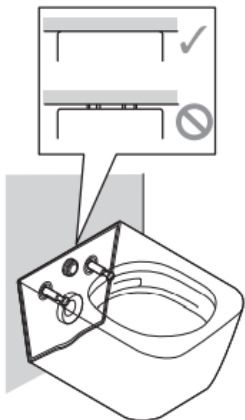

4

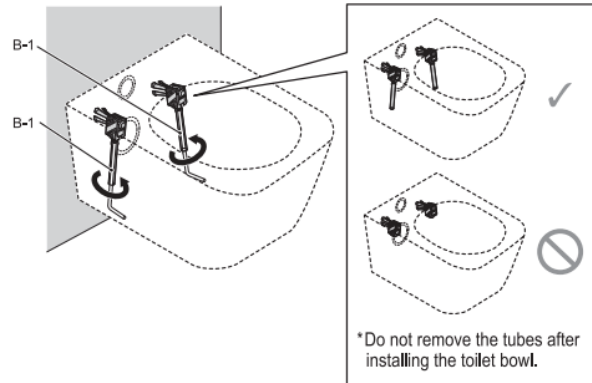

For repairs & maintenance, where the dismantling and reinstalling of the wall hung water closet is concern, it is advisable to change the fixing kit.

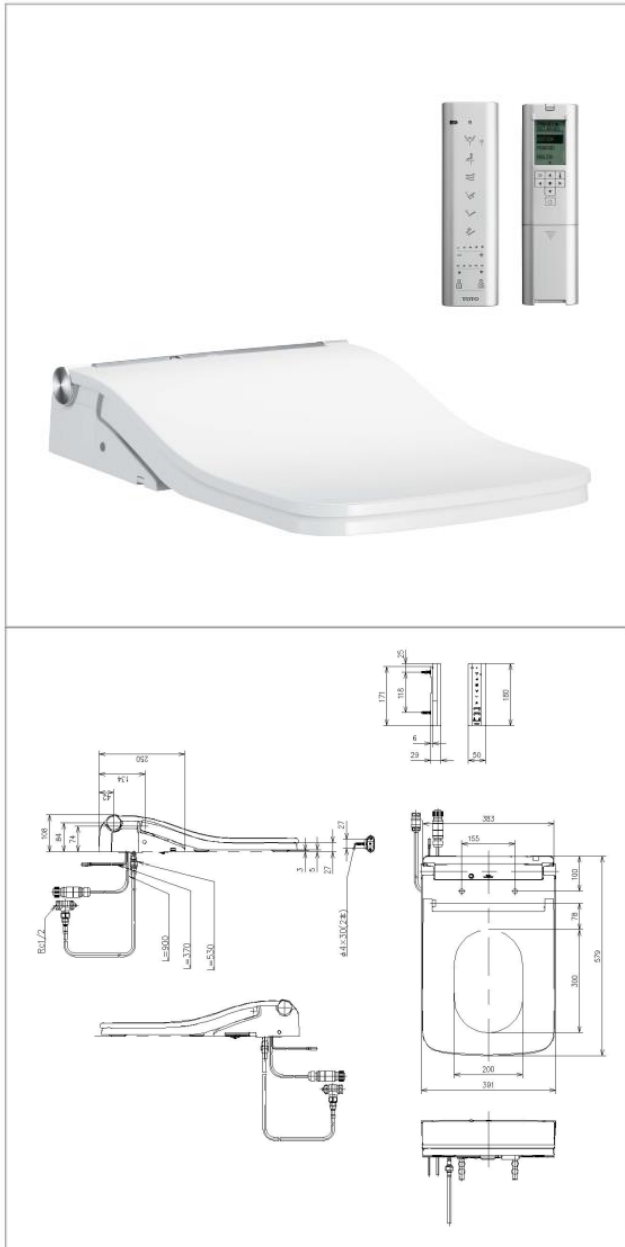

Brand

TOTO

Product Name

TCF804C2Z#NW1

Description

- Fully equipped with comfortable rear, front and oscillating cleansing functions
- Adjustable warm air dryer
- Powerful Auto deodorizer activates after every usage
- HEATED SEAT with temperature control
- PREMIST water is sprayed inside the toilet bowl to make it difficult for dirt to adhere
- Auto lid opening and closing
- WASHLET with remote
- Come with ABB F202 RCCB
- Refer to 2nd page for detail functions

Colour / Material

White / Urea Resin

Specifications

Size	: 383W x 579D x 108H mm
Water pressure	: 0.05MPa ~ 0.75MPa
Power rating	: 220 ~ 240V, 50/60Hz , 826 ~ 837W
Power cord	: 900mm



WASHLET FUNCTIONS

Hygiene Functions		Cleansing Functions		Comfort Functions	
Ewater+	•	Air in Wonder Wave	•	Auto Lid Opening and Closing	•
Antibacterial Feature	•	Rear Cleansing	•	Soft Close Seat and Lid	•
Removable Lid		Soft Rear Cleansing	•	Deodorizer	•
One-Touch Removable of Main Unit	•	Front Cleansing	•	Dryer	•
Nozzle Cleaning Button	•	Wide Front Cleansing		Heated Seat	•
Self-Cleaning Nozzle	•	Oscillating (Move) Cleansing	•	Soft Light	•
Pre-mist	•	Pulsating Cleansing	•	Remote Control	•
		Nozzle Position Adjustment	•	Water Pressure	•
				Personal Setting	•
				Temperature	•
				Energy Saver	•

Electrical Installation Requirements for TOTO Washlet & Neorest

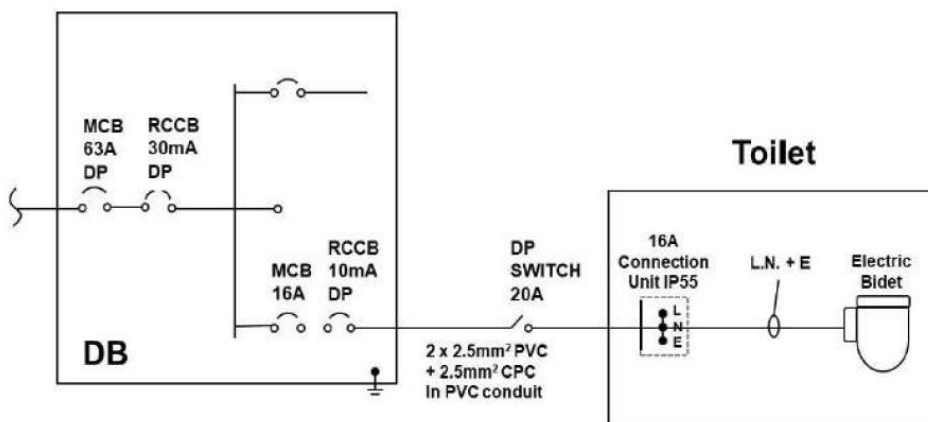

Remarks:

The above information is a guideline and subjected to local code of practice and requirement. Please engage competent Electrical Contractor and Licensed Electrical Worker to carry out the work prior for inspection and certification.



Brand

TOTO

Product Name

WH173SGAT

Description

- Concealed cistern tank
- Dual flush system
- Compatible with WASHLET +

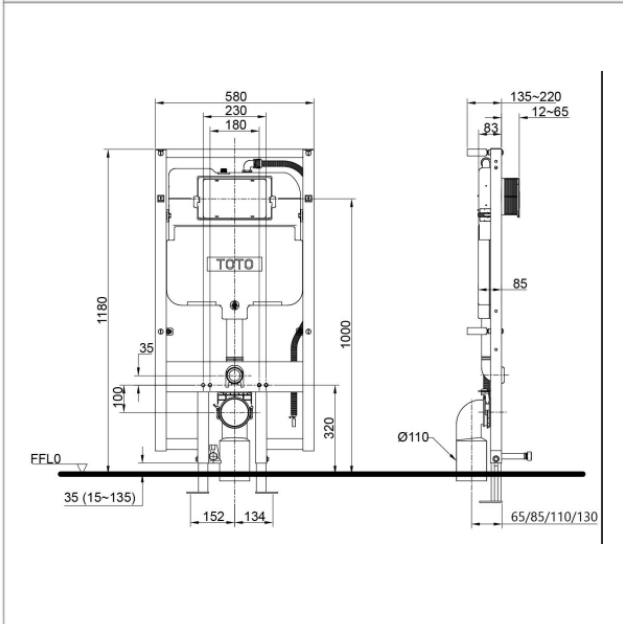

Colour / Material

Specifications

Water Use : 4.0 L / 3.0 L
Water Pressure : 0.05MPa ~ 0.75MPa



<p>Model Name: MB176G#WH Material: Glass Glass with white buttons</p>	<p>Model Name: MB174P#SS Material: ABS Sliver matte buttons</p>	<p>Model Name: MB171M#SS Material: Stainless Steel Stainless steel buttons</p>
<p>Model Name: MB175M#SS Material: Stainless Steel Stainless steel buttons</p>	<p>Model Name: MB170P#SS Material: ABS Sliver matte buttons</p>	